

CON-TAR

Monitoring ◊ Control ◊ Optimization

Nico Zobel

Technische Universität Berlin / Berlin Institute of Technology
Department of Energy Engineering
Chair for Energy Process Technology and
Conversion Technologies for Renewable Energies (EVUR)
Fasanenstr. 89, D-10623 Berlin
nico.zobel@tu-berlin.de

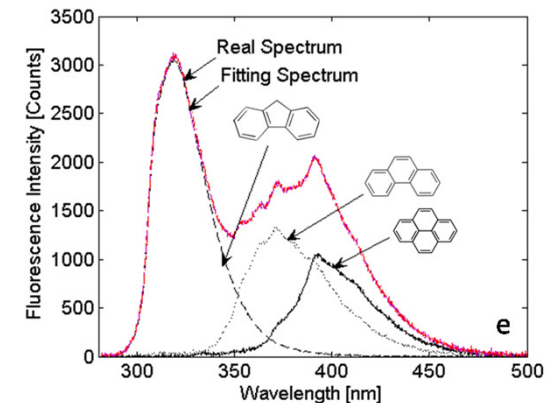
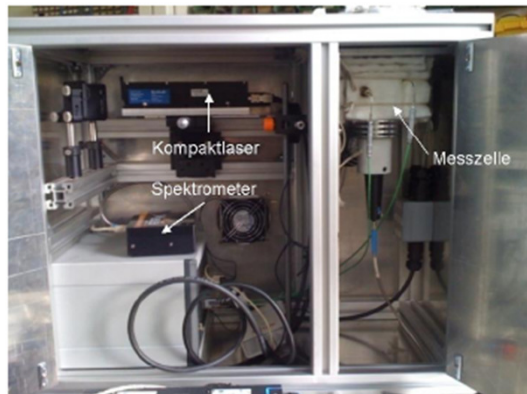

Intention:

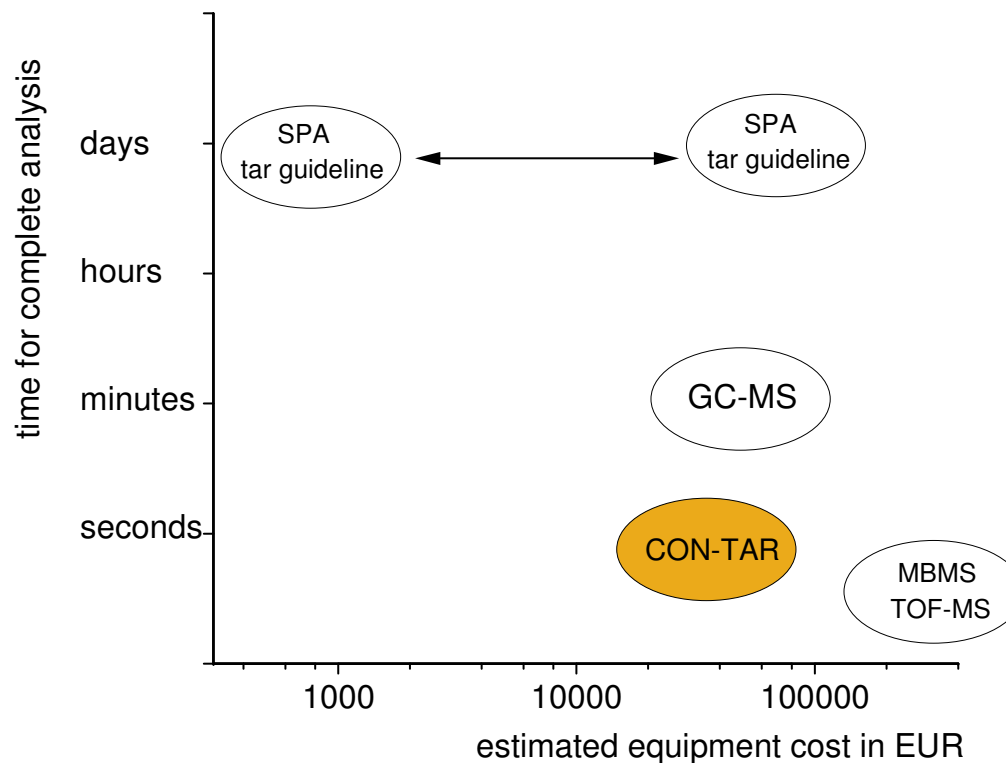

Field of application:

research and industry,
for permanent monitoring/control of gas quality

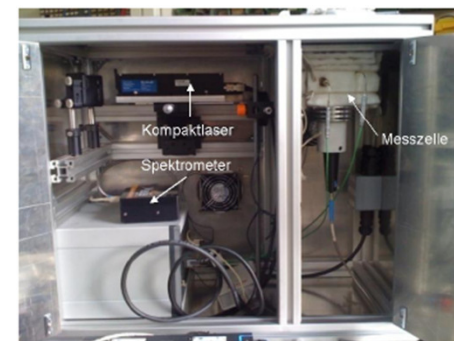
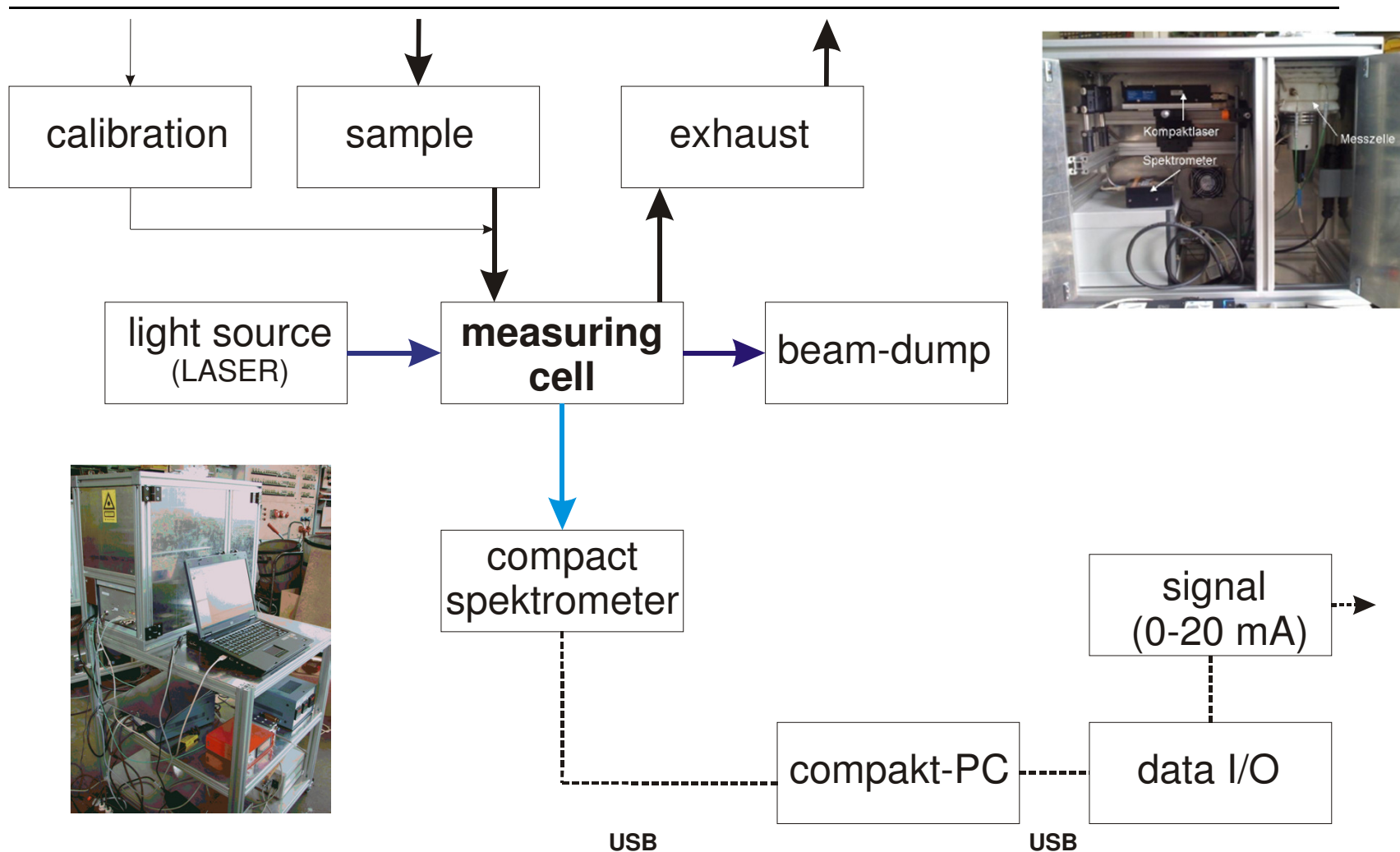

CONTAR – **CON**tinuos **TAR**-analyzer

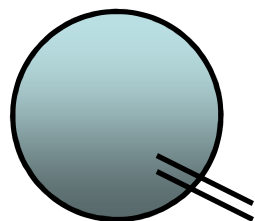

Possible impact of tar concentration gradient in pipe cross section

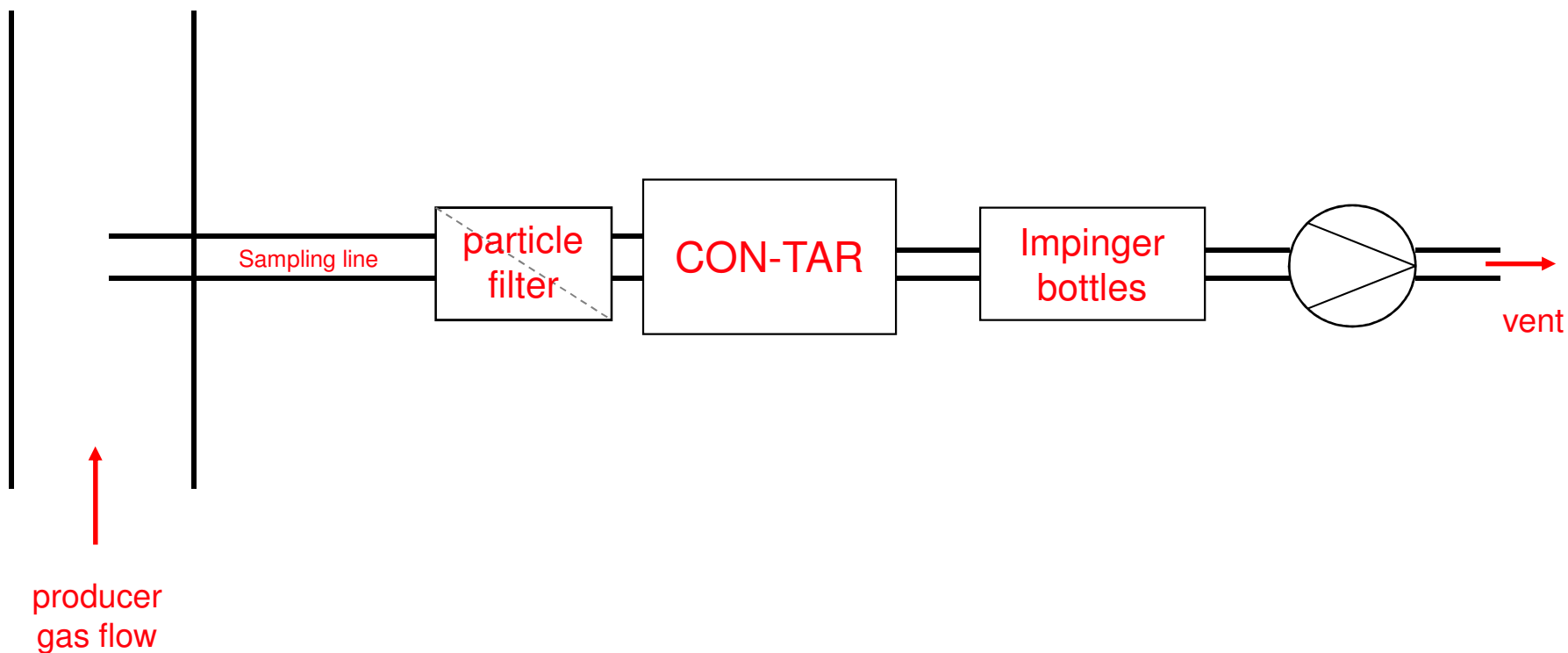

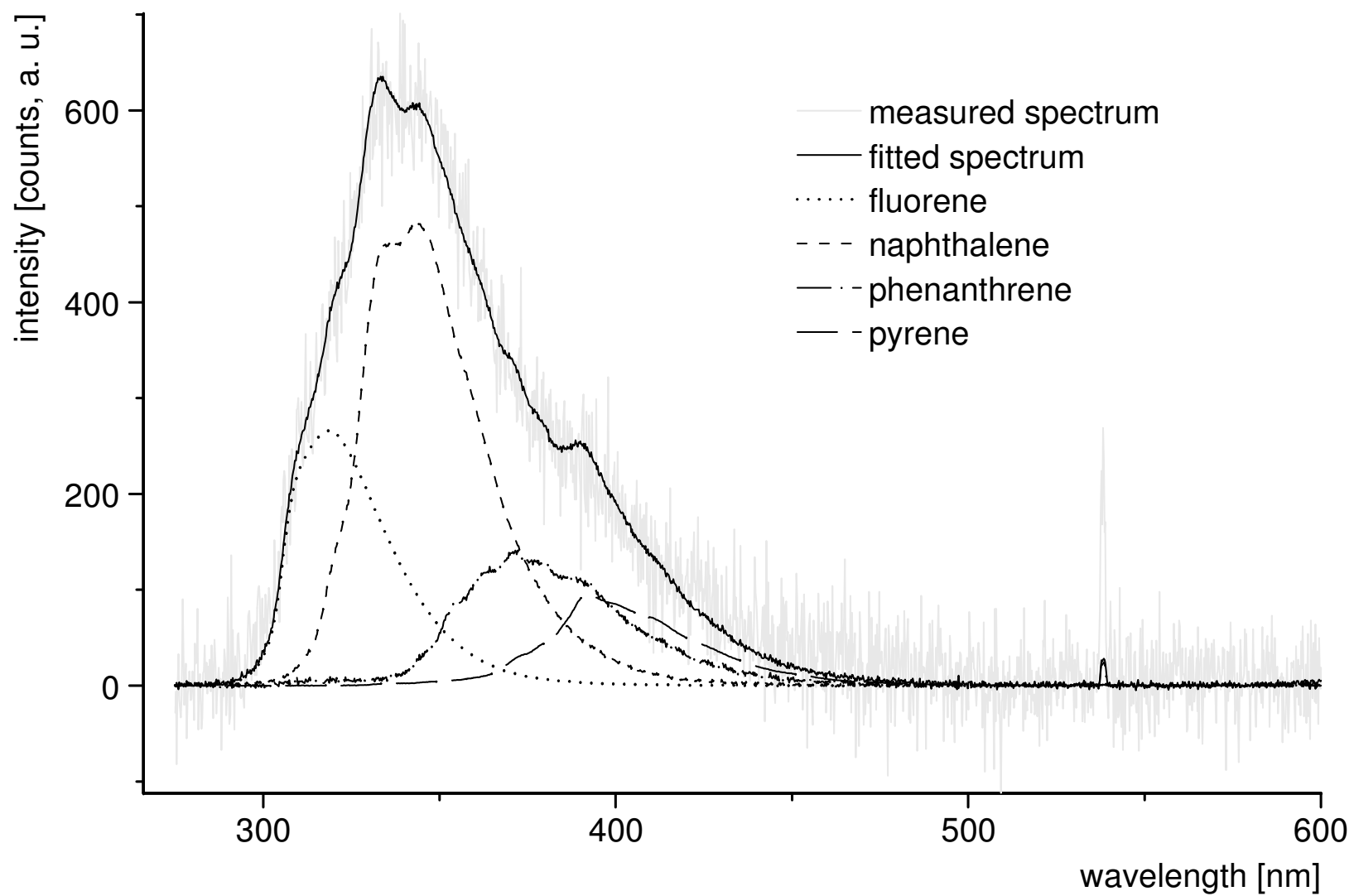

Robustness:	optical system + measuring cell very robust impinger bottles not practical, constant volume flow important
Operation:	can be learned within minutes
Sensitivity:	Naphthalene > 50 mg/Nm ³ , Phenol > 200 mg/Nm ³ (?)
Selectivity:	depends on mixture, some fluorescence peaks overlap
Repetition:	results every 10 seconds
Reproducibility:	?
Stability:	maximum continuous test duration: two weeks, no failures so far
Benchmark:	+/- 20% compared to GC/MS

Status:

- periphery not yet ready for fully automatic operation
- rather costly parts for excitation (uv-laser) and detection (spectrometer);
depending on desired details in measurement cost reduction possible

Future work:

- (1) Improve periphery:
 - Replace impinger bottles & pump with ejector pump (+ burner)
 - Control sampling volume flow
- (2) Implementation and testing of less expensive light sources and detectors

Thank you for yor attention!



Federal Ministry
of Economics
and Technology



Federal Ministry
of Food, Agriculture
and Consumer Protection

